

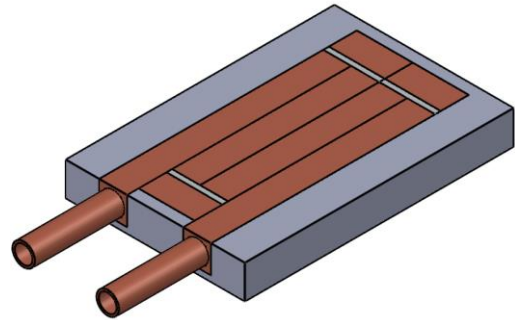

HydroTrak 4-PASS COLD PLATE

The HydroTrak 4-pass liquid cooled cold plate is a high-performance machined aluminum plate with a 4-pass interlocking copper tube configuration. The HydroTrak’s increased cooling surface area and enhanced heat conduction angles provide significantly improved heat transfer dynamics. The HydroTrak technology delivers up to 3 times the cooling capabilities of traditional liquid cold plates. The HydroTrak is designed to allow high power resistors, IGBTs, SCRs diodes to run at peak efficiency and is also suitable for many other high power density applications.



THERMAL PERFORMANCE

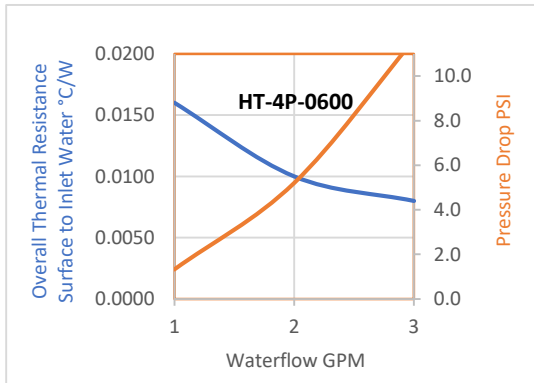

DRAWING

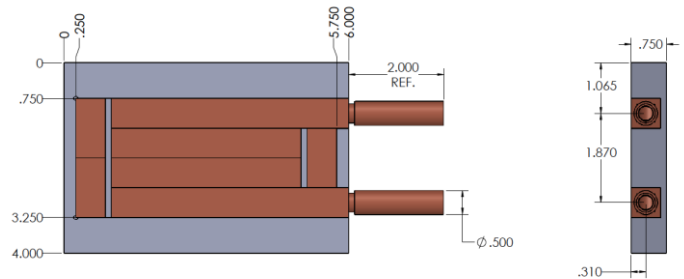

FEATURE AND BENEFITS

- Fly-cut tube surface ensure precision flatness & optimal thermal performance
- Machinable for device mounting and other machining requirements
- Easily customized to meet specific end design criteria

OPTIONS

- Material Options
- Tube: Copper
 - Base: Aluminum (shown), Copper

D6 also supplies the following items for your convenience



- Beaded tube ends, flared tube ends, threaded male & female fittings to accept hose barbs or other fittings.



- Thermal compounds; silicone & non-silicone. See the D6 web site for available sizes.