

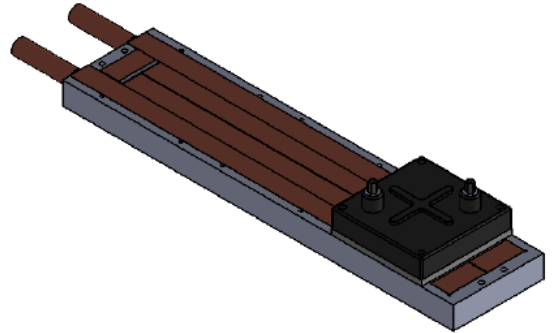

## HydroTrak Tap 2000 4-PASS COLD PLATE

The HydroTrak Tap 2000 cold plates are designed specifically for the Tap resistors. They allow the resistors to run at peak efficiency without requiring end users to d-rate the performance in their final application. The HydroTrak 4-pass liquid cooled cold plate is a high-performance machined aluminum plate with a 4-pass interlocking copper tube configuration. The HydroTrak’s increased cooling surface area, and enhanced heat conduction angles, provide significantly improved heat transfer dynamics and up to 3-times the cooling capabilities of traditional liquid cold plates.



### THERMAL PERFORMANCE

### DRAWING

**Consult factory for thermal analysis**

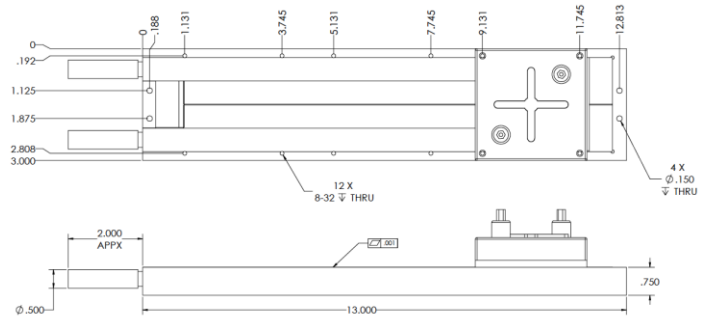

### FEATURE AND BENEFITS

- Fly-cut tube surface ensure precision flatness & optimal thermal performance
- Machinable for device mounting and other machining requirements
- Easily customized to meet specific end design criteria

### OPTIONS

- Material Options
- Tube: Copper
  - Base: Aluminum (shown), Copper

### D6 also supplies the following items for your convenience



- Beaded tube ends, flared tube ends, threaded male & female fittings to accept hose barbs or other fittings.



- Thermal compounds; silicone & non-silicone. See the D6 web site for available sizes.