

4

3

2

1

D

D

C

C

B

B

A

A

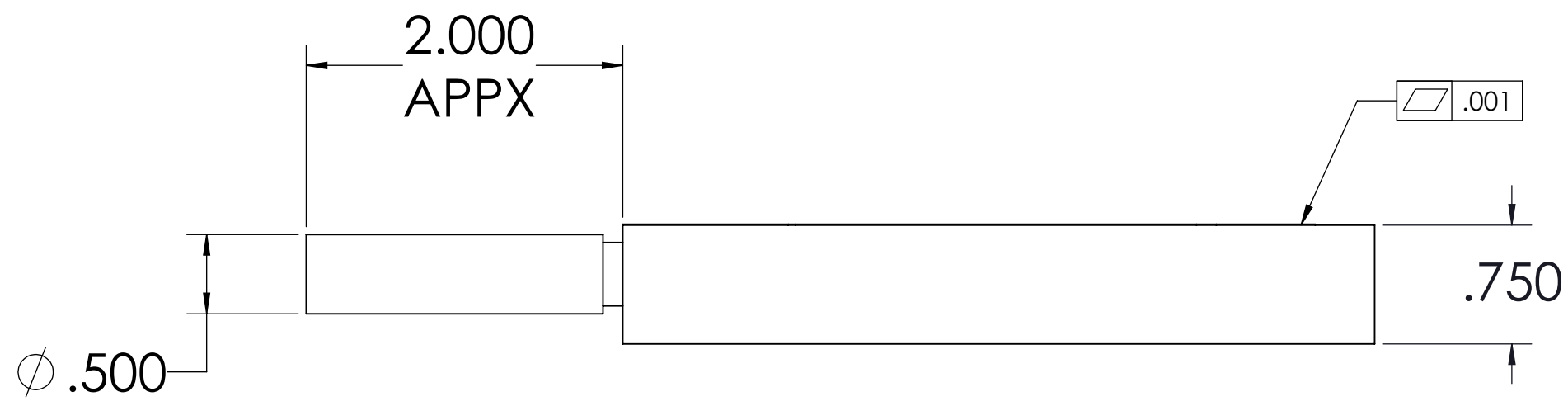
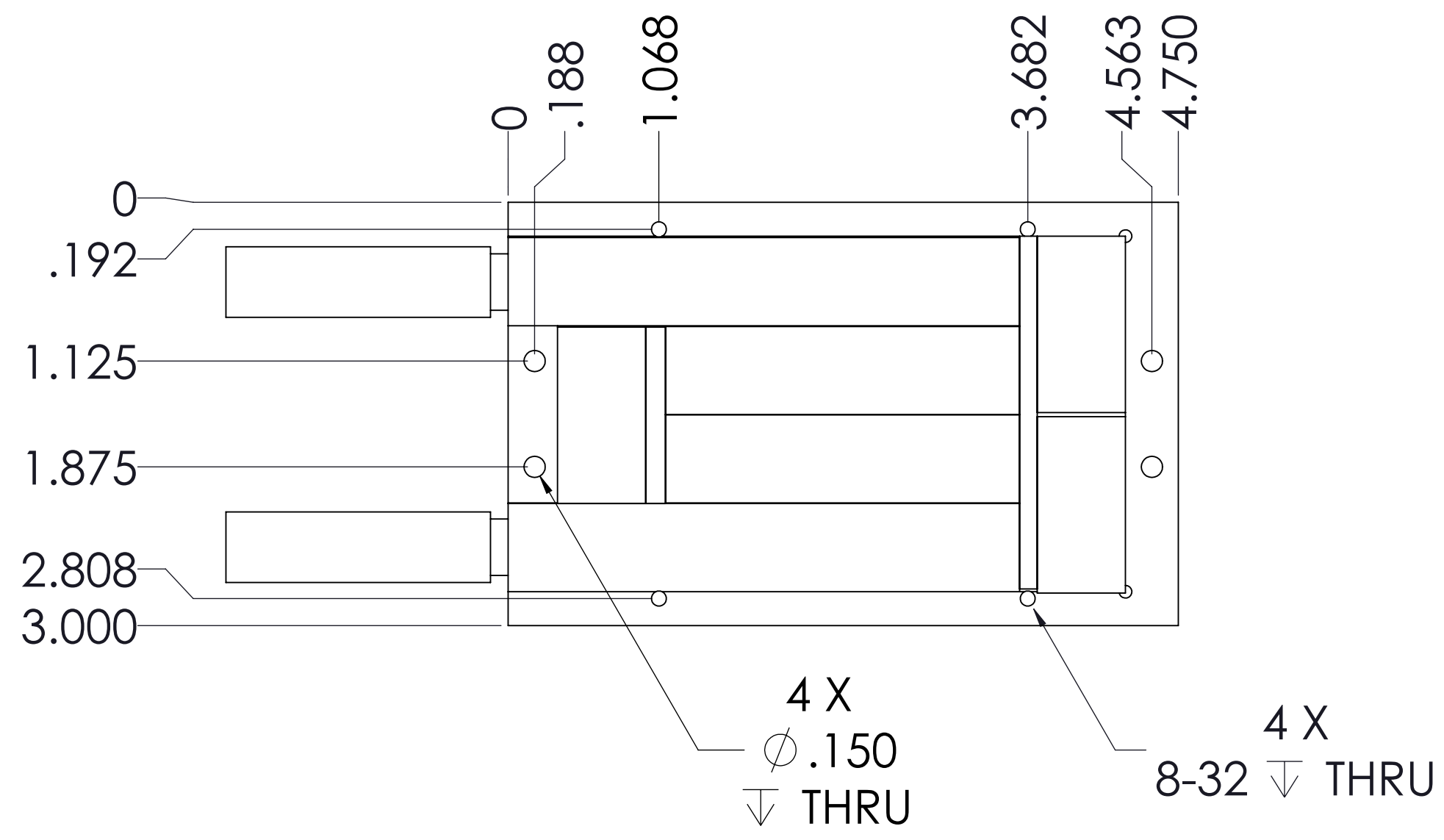
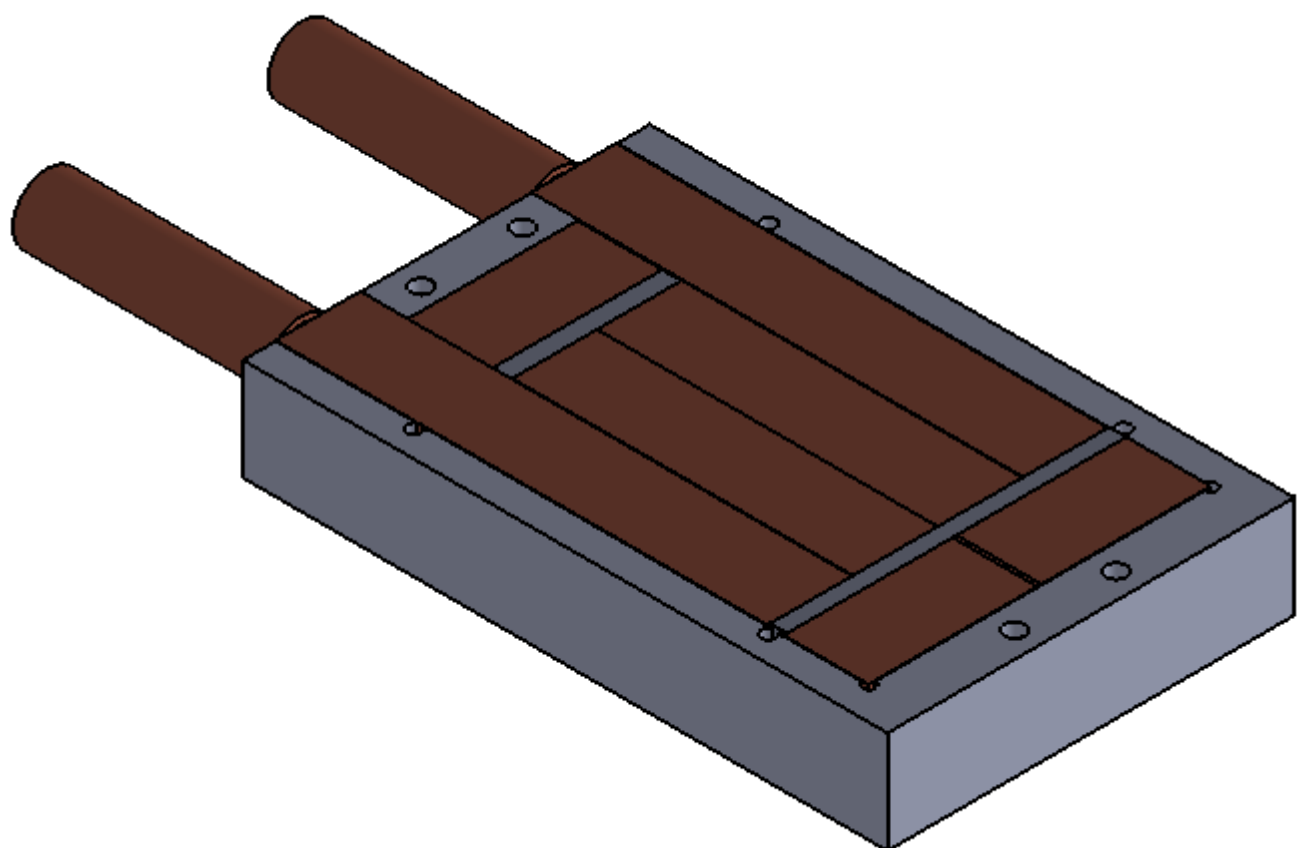

801 S UNION ST.
LAWRENCE, MA 01843
978-989-0981

HT-TAP2000-1			
SIZE C	CAGE CODE	DWG NO. 50-0208	REV 1
SCALE 1:1	SHEET		