

4

3

2

1

D

D

C

C

B

B

A

A

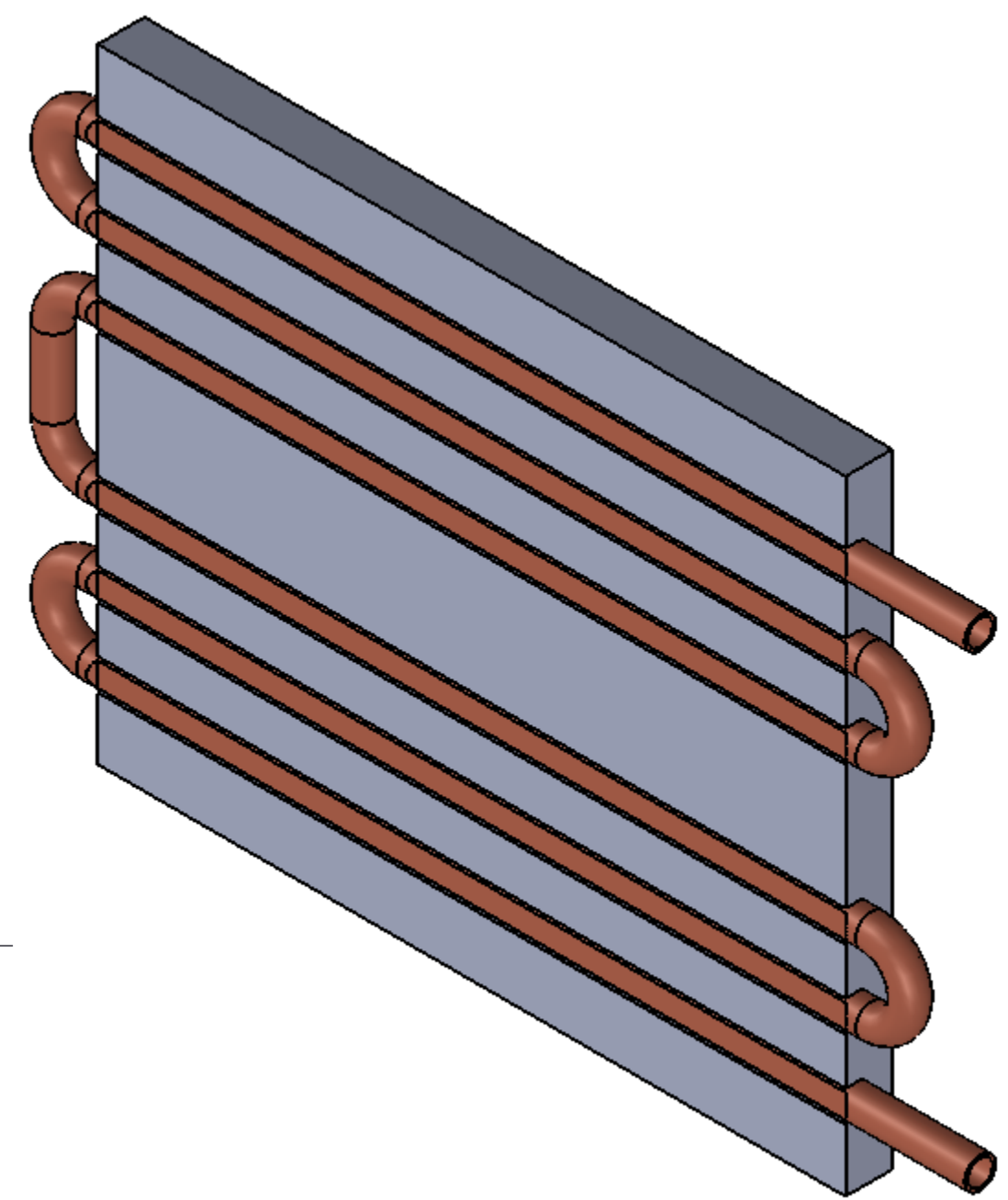
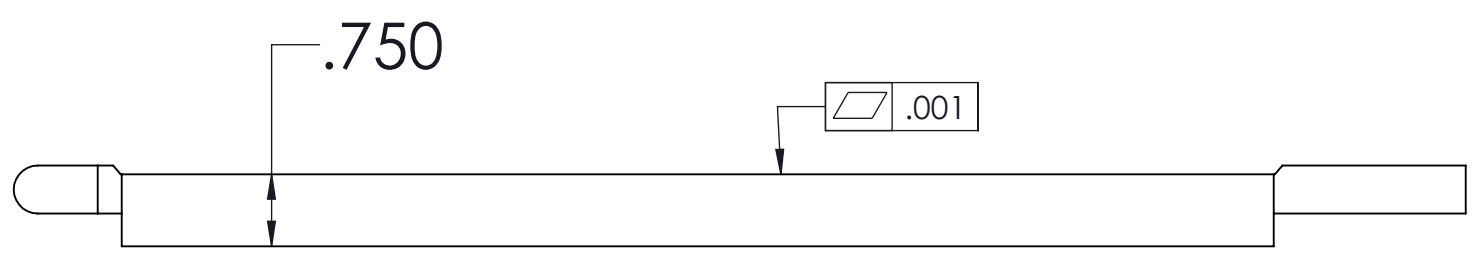
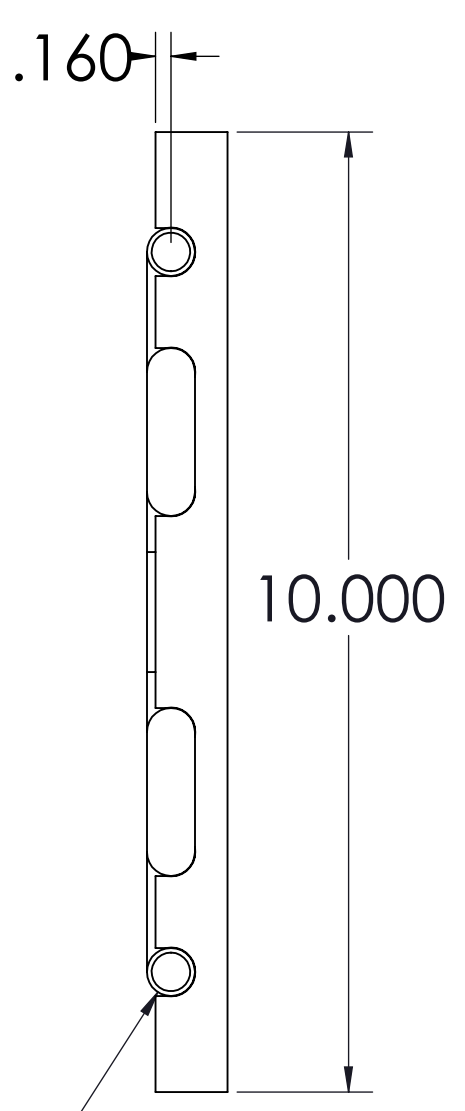
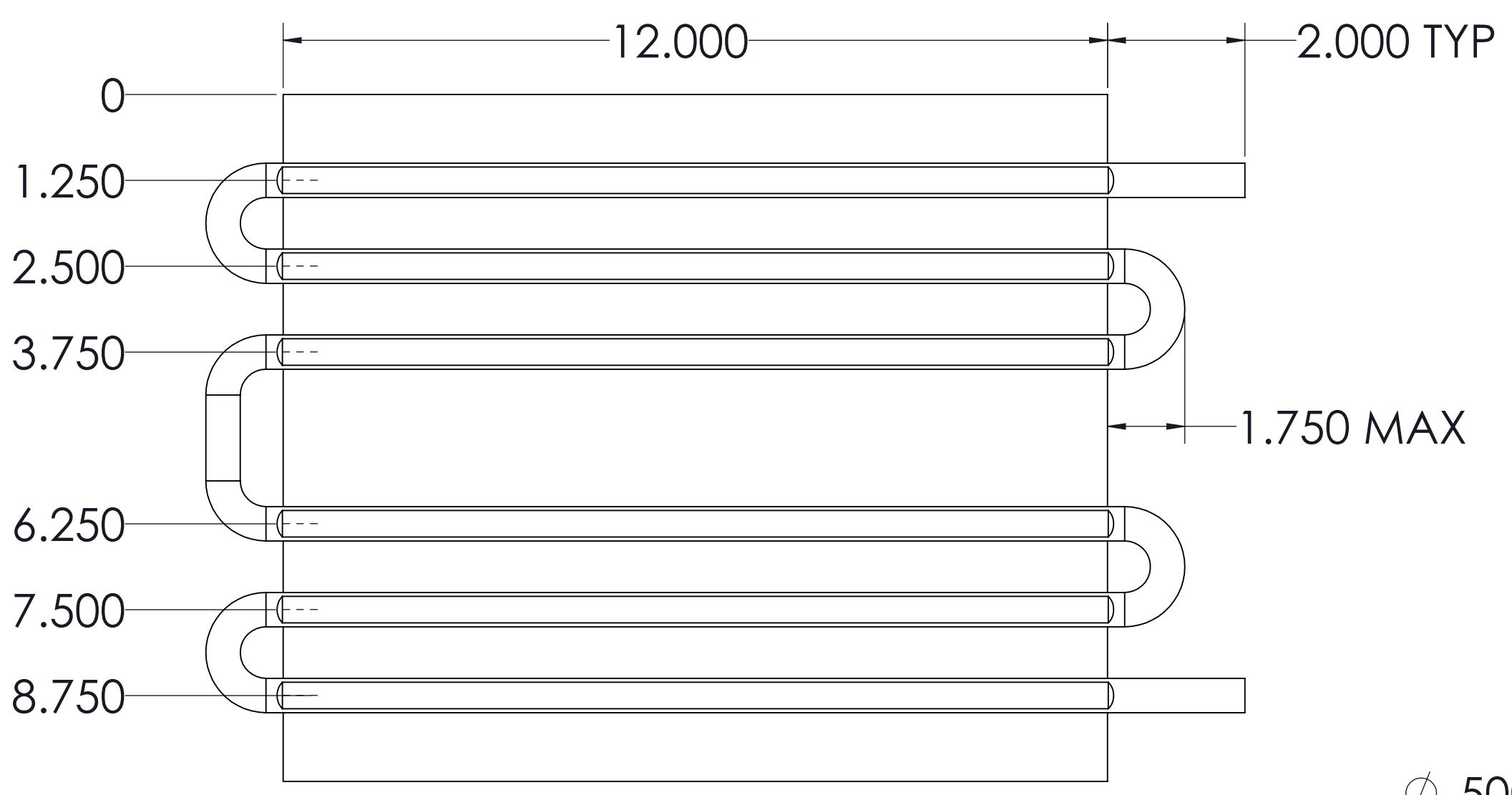

801 S UNION ST.
LAWRENCE, MA 01843
978-989-0981

HB-6P-1200-CU-C

SIZE C	CAGE CODE	DWG NO. -	REV 0
SCALE 1:2	SHEET		