

4

3

2

1

D

D

C

C

B

B

A

A

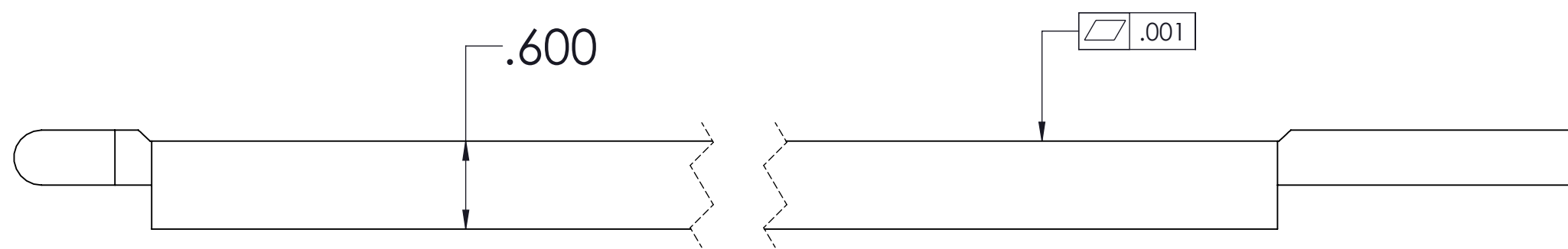
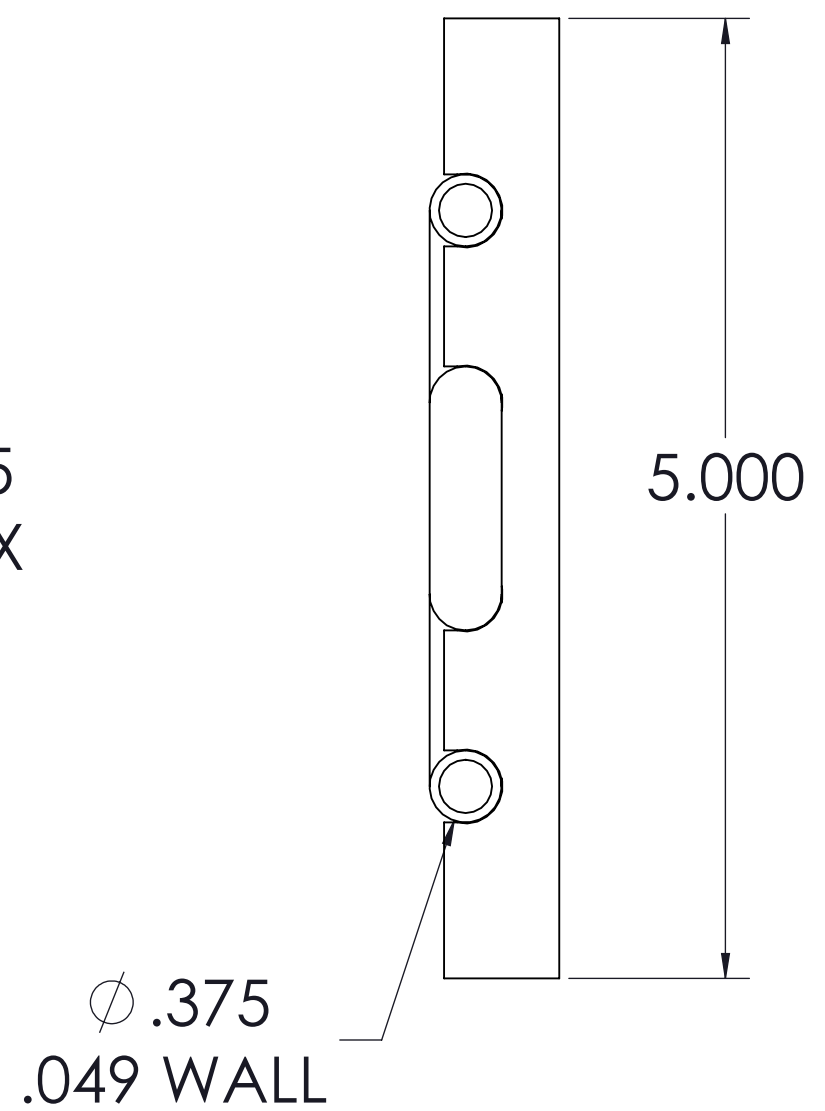
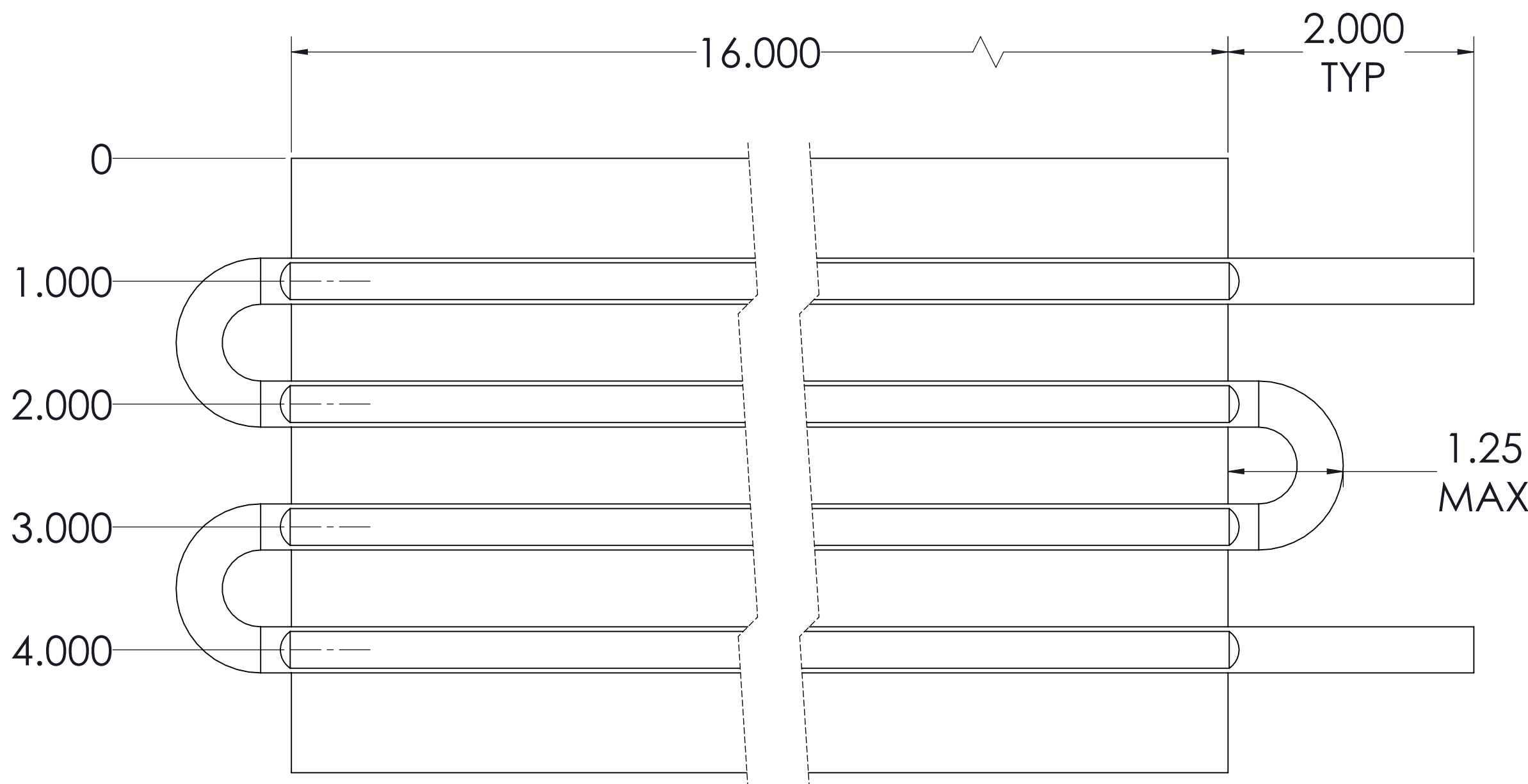
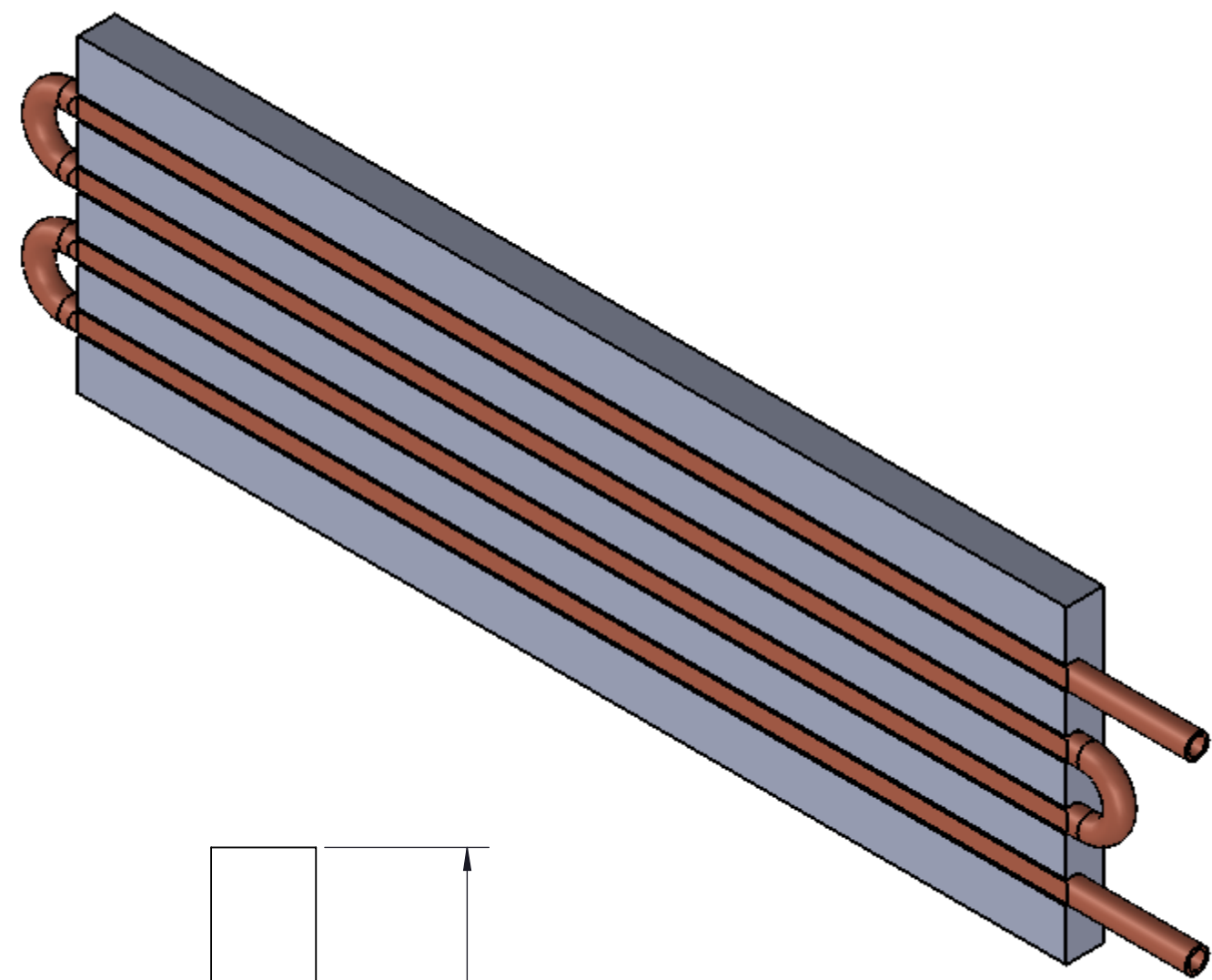

801 S UNION ST.
LAWRENCE, MA 01843
978-989-0981

HB-4P-1600-CU-C			
SIZE C	CAGE CODE	DWG NO. -	REV 0
SCALE 1:1	SHEET		